

ALTERNA SCORREVOLE
WARDROBES WITH SLIDING DOORS – ALTERNA



scheda tecnica data sheet

ALTERNA SCORREVOLE

WARDROBES WITH SLIDING DOORS – ALTERNA

ALTEZZE HEIGHTS

comprensiva di piedino regolabile da 0.6 a 2.5 cm adjustable foot from 0.6 to 2.5 cm included

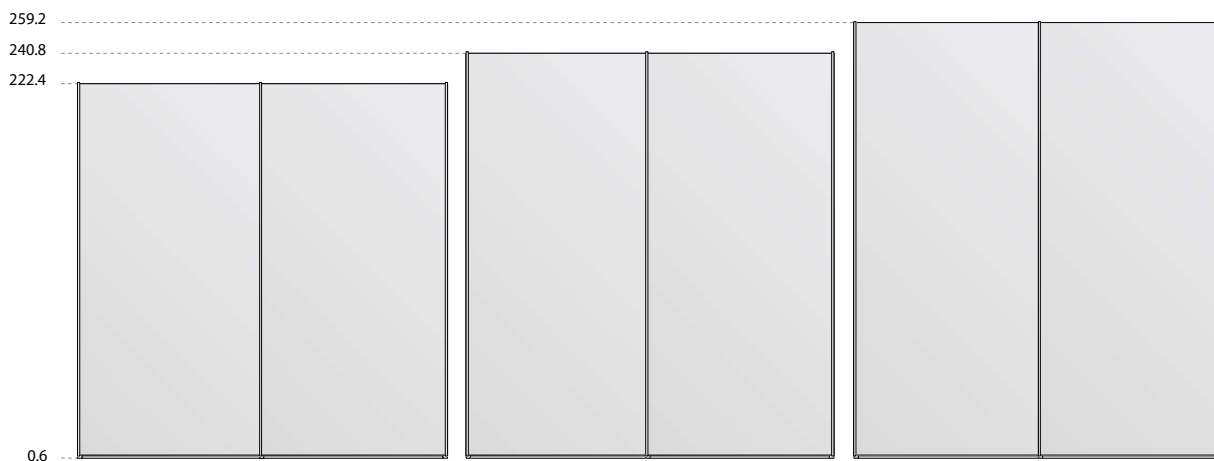

Altezze fianchi escluse di piedino 221.8 – 240.2 – 258.6 cm
 Heights of sides without foot 221.8 – 240.2 – 258.6

LARGHEZZE WIDTHS

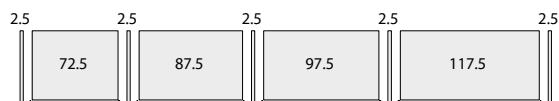

PROFONDITÀ DEPTHS

PLANA – GOLA – MIXER – MIXER GLASS – DOUBLE – DOUBLE GLASS



COMPASS – MONDRIAN



Terminale con appendino
 End unit with hanging rail

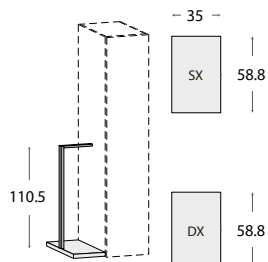

ALTERNA SCORREVOLE - ANTA PLANA
 PLANA SLIDING DOOR

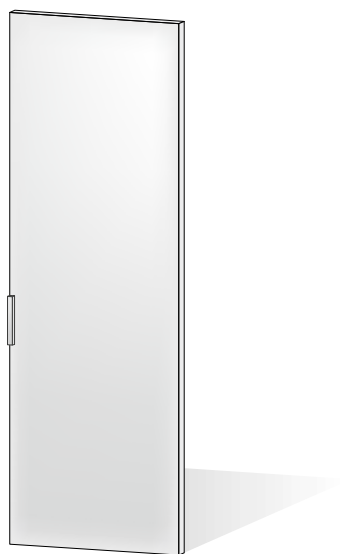

FRONTALI FRONTS

Fascia 1

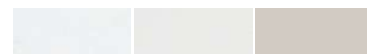

bianco talco
talc white

pomice
pumice

cashmere
cashmere



olmo ash
ash elm

Fascia 2



arena
arena

selce
flint

ottanio
octane



ardesia
slate



rovere natural
natural oak



noce
walnut



lignum dark
lignum dark



opus calce
opus lime



opus cemento
opus concrete



opus mattone
opus brick



cretto cashmere
cretto cashmere



cocò
coco

N.B.: Attrezzabile con maniglia RULER nei colori:

bianco talco - pomice - cashmere - arena - selce - ottanio - ardesia - opus calce - opus cemento - opus mattone - brunito

N.B.: Can be fitted with RULER handle in the following colours:

talc white - pumice - cashmere - arena - flint - octane - slate - opus lime - opus concrete - opus brick - burnished

Attrezzabile con maniglia PLAN nei colori: Bianco talco - 0 chimico - Brunito

Can be fitted with PLAN handle in the following colours: Talc white - 0 finish - Burnished

ALTERNA SCORREVOLE - ANTA GOLA

GOLA SLIDING DOOR

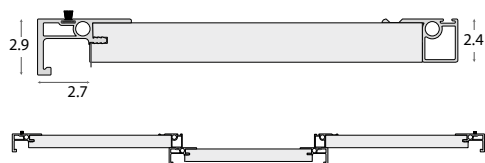

FRONTALI FRONTS

Fascia 1



Fascia 2

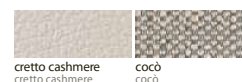
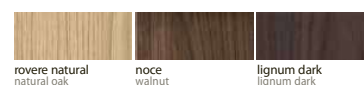

CARATTERISTICHE TECNICHE

L'anta scorrevole Gola è composta da:

- pannello melaminico in agglomerato di legno Sp. 2.2 cm
- Finitura profilo Gola
- bianco talco - pomice - cashmere - arena - selce - ottanio - ardesia - opus calce - opus cemento - opus mattone - brunito
- dotata di dispositivo raddrizza-anta
- con sistema di scorrimento ammortizzato di serie in apertura e chiusura

TECHNICAL CHARACTERISTICS

Gola sliding door composed of:

- wood agglomerate melamine panel Th. 2.2 cm
- Gola profile finish
- talc white - pumice - cashmere - arena - flint - octane - slate - opus lime - opus concrete - opus brick - burnished

ALTERNA SCORREVOLE - ANTA MIXER

MIXER SLIDING DOOR

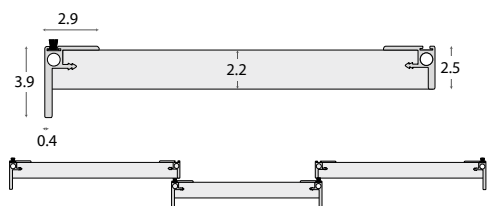
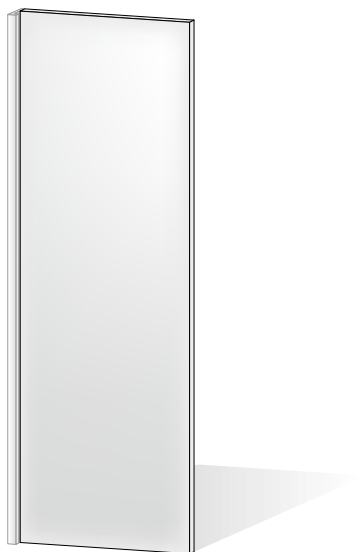

FRONTALI FRONTS

Fascia 1



Fascia 2

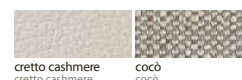
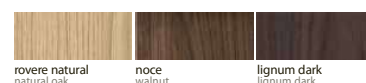

CARATTERISTICHE TECNICHE

L'anta scorrevole Mixer è composta da:

- pannello melaminico in agglomerato di legno Sp. 2.2 cm

- Finitura profilo Mixer

- bianco talco - pomice - cashmere - arena - selce - ottanio - ardesia - opus calce - opus cemento - opus mattone - brunito

- dotata di dispositivo raddrizza-anta

- con sistema di scorrimento ammortizzato di serie in apertura e chiusura

TECHNICAL CHARACTERISTICS

Mixer sliding door composed of:

- wood agglomerate melamine panel Th. 2.2 cm

- Mixer profile finish

- talc white - pumice - cashmere - arena - flint - octane - slate - opus lime - opus concrete - opus brick - burnished

- fitted with straighten-door device.

- with standard soft-close sliding system

ALTERNA SCORREVOLE - ANTA MIXER GLASS
MIXER GLASS SLIDING DOOR

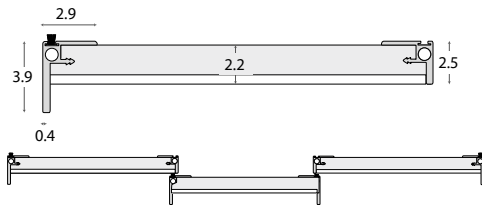

FRONTALI FRONTS

Profili e maniglie

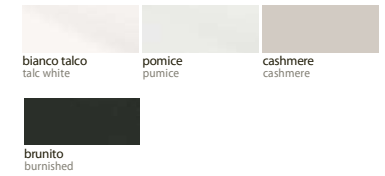

specchio (dotato di pellicola di sicurezza antischeggia)

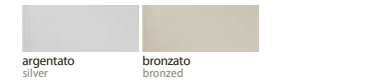

vetri lucidi e opachi temprati



CARATTERISTICHE TECNICHE

L'anta scorrevole Mixer glass è composta da:

- pannello melaminico in agglomerato di legno Sp. 1.8 cm e vetro 0.4 cm con profili verticali in alluminio con finitura interna SESAMO – NOCE
- Finitura profilo Mixer:
- bianco talco - pomice - cashmere - arena - selce - ottanio - ardesia - opus calce - opus cemento - opus mattone - brunito
- dotata di dispositivo raddrizza-anta
- con sistema di scorrimento ammortizzato di serie in apertura e chiusura

Finitura vetro:

- Specchio argentato o bronzato
- Vetro laccato lucido o opaco

TECHNICAL CHARACTERISTICS

Mixer sliding door composed of:

- wood agglomerate melamine panel Th. 1.8 cm and glass 0.4 cm with vertical aluminium profiles with internal finish SESAME – WALNUT
- Mixer profile finish:
- talc white - pomice - cashmere - arena - flint - octane - slate - opus lime - opus concrete - opus brick - burnished
- fitted with straighten-door device.
- with standard soft-close sliding system

Glas finish:

- Bronzed or silver mirror
- Matt or glossy lacquered glass

ALTERNA SCORREVOLE - DOUBLE DOUBLE SLIDING DOOR

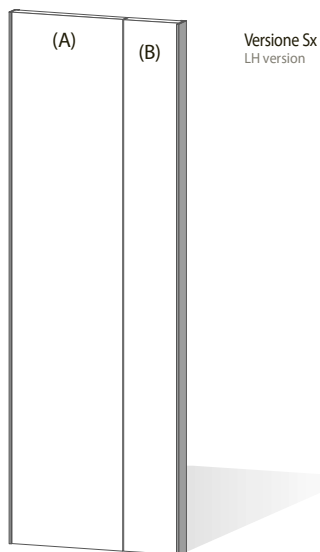

FRONTALI FRONTS

Fascia 1

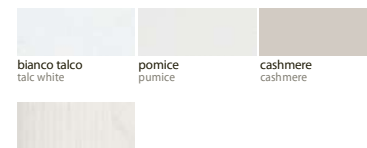

Fascia 2

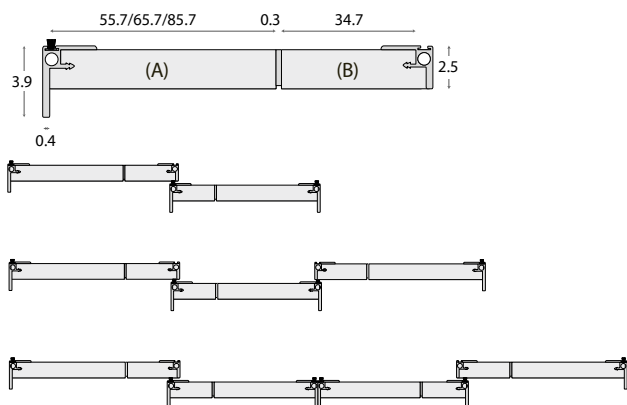
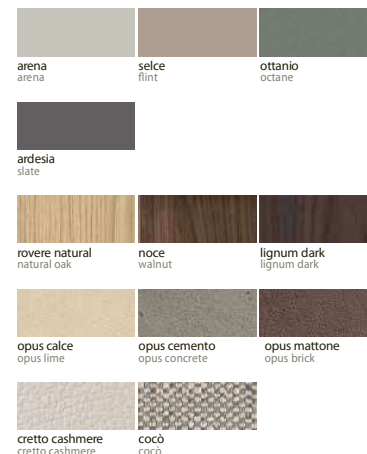

CARATTERISTICHE TECNICHE

L'anta scorrevole Double pannello è composta da:

- pannello in melaminico in agglomerato di legno Sp. 2.2 cm

- Finitura profilo Double

bianco talco - pomice - cashmere - arena - selce - ottanio - ardesia - opus calce - opus cemento - opus mattone - brunito

- dotata di dispositivo raddrizza-anta

- con sistema di scorrimento ammortizzato di serie in apertura e chiusura

TECHNICAL CHARACTERISTICS

Panel Double sliding door composed of:

- wood agglomerate melamine panel Th. 2.2 cm

- Double handle finish

talc white - pumice - cashmere - arena - flint - octane - slate - opus lime - opus concrete - opus brick - burnished

- fitted with straighten-door device.

- with standard soft-close sliding system

ALTERNA SCORREVOLE - DOUBLE GLASS

DOUBLE GLASS SLIDING DOOR

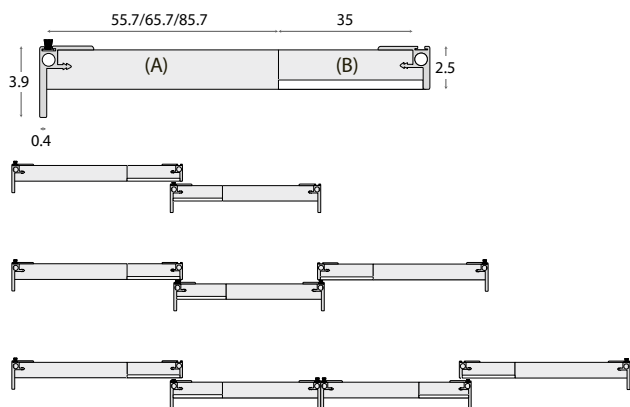
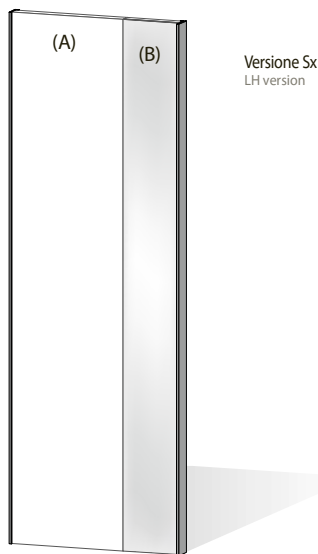

CARATTERISTICHE TECNICHE

L'anta scorrevole Double glass pannello è composta da:

- pannello in melaminico in agglomerato di legno Sp. 2.2 cm e pannello vetro (pannello 1.8 cm e vetro 0.4 cm)

- Finitura profilo Double

bianco talco - pomice - cashmere - arena - selce - ottanio - ardesia - opus calce - opus cemento - opus mattone - brunito

- dotata di dispositivo raddrizza-anta

- con sistema di scorrimento ammortizzato di serie in apertura e chiusura

L'anta è composta da due parti:

(A) solo pannello

(B) larga 35 cm con applicato:

- specchio argentato o bronzato
- vetro laccato lucido o opaco

TECHNICAL CHARACTERISTICS

Panel Double glass sliding door composed of:

- wood agglomerate melamine panel Th. 2.2 cm and glass panel (panel 1.8 cm and glass 0.4 cm)

- Double handle finish

talco white - pumice - cashmere - arena - flint - octane - slate - opus lime - opus concrete - opus brick - burnished

- fitted with straighten-door device.

- with standard soft-close sliding system

The door is in two parts:

(A) only panel

(B) W. 35 cm with applied:

- bronzed an silver mirror
- matt or glossy lacquered glass

FRONTALI FRONTS

Fascia 1

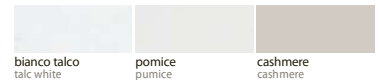

Fascia 2

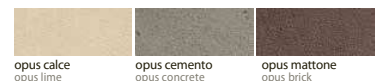

FRONTALI FRONTS

Profili e maniglie

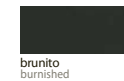

specchio (dotato di pellicola di sicurezza antischeggia)

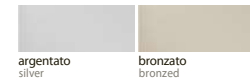

vetri lucidi e opachi temprati

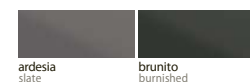

ALTERNA SCORREVOLE - COMPASS

COMPASS SLIDING DOOR

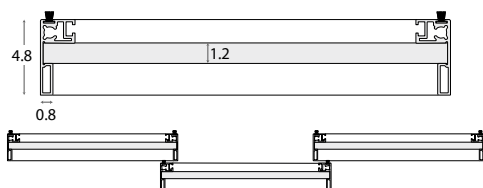

FRONTALI FRONTS

Fascia 1



olmo ash
ash elm

Fascia 2



ardesia
slate

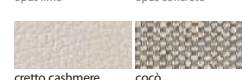
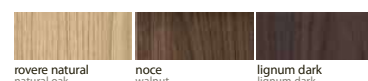

cretto cashmere
cretto cashmere

cocò
coco

CARATTERISTICHE TECNICHE

L'anta scorrevole Compass è composta da:

- pannello melaminico in agglomerato di legno Sp. 1.2 cm
- Cornice perimetrale Compass:

Finiture: bianco talco - brunito

- dotata di dispositivo raddrizza-anta
- con sistema di scorrimento ammortizzato di serie in apertura e chiusura

TECHNICAL CHARACTERISTICS

Compass sliding door composed of:

- wood agglomerate melamine panel Th. 1.2 cm
- Compass perimetral frame:

Finishes: talc white -burnished

- fitted with straighten-door device.
- with standard soft-close sliding system

ALTERNA SCORREVOLE - MONDRIAN

MONDRIAN SLIDING DOOR



ANTA con versione SX – DX
Versione 5x

FRONTALI FRONTS

Fascia 1

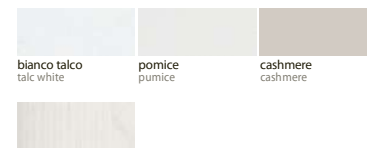

Fascia 2

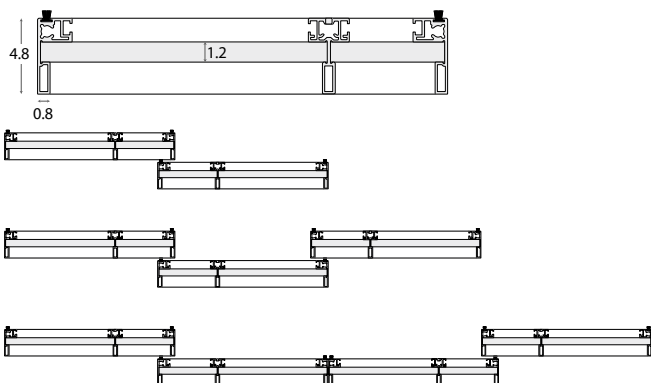
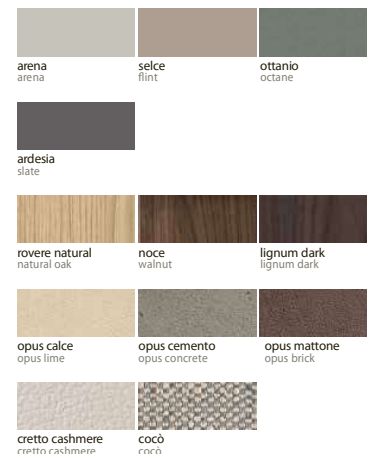

CARATTERISTICHE TECNICHE

- L'anta scorrevole Mondrian è composta da:
- pannello melaminico in agglomerato di legno Sp. 1.2 cm, con possibilità di colorare le sezioni in modo differente.
 - Cornice perimetrale Compass: con profilo verticale – orizzontale
 - Finiture: bianco talco -brunito
 - dotata di dispositivo raddrizza-anta
 - con sistema di scorrimento ammortizzato di serie in apertura e chiusura

TECHNICAL CHARACTERISTICS

- Mondrian sliding door composed of:
- wood agglomerate melamine panel Th. 1.2 cm, with the possibility to use different colours on different sections.
 - Compass perimetral frame: with vertical–horizontal profile
 - Finishes: talc white -brunished
 - fitted with straighten–door device.
 - with standard soft–close sliding system

DIMENSIONI PANNELLI

